



FreeAgent Theater™ HD MEDIA PLAYER SOLUTION

FCC DECLARATION OF CONFORMANCE
This device complies with Part 15 of the FCC Rules. Operation is subject to the following two conditions: (1) this device may not cause harmful interference, and (2) this device must accept any interference received, including interference that may cause undesired operation.

CLASS B
This equipment has been tested and found to comply with the limits for a Class B digital device, pursuant to Part 15 of the FCC Rules. These limits are designed to provide reasonable protection against harmful interference in residential installation.

This equipment generates, uses, and can radiate radio frequency energy and, if not installed and used in accordance with the instructions, may cause harmful interference to radio communications.

However, there is no guarantee that interference will not occur in a particular installation. If this equipment does cause harmful interference to radio or television reception, which can be determined by turning the equipment off and on, the user is encouraged to try to correct the interference by one or more of the following measures:

- Reorient or relocate the receiving antenna.
- Increase the separation between the equipment and receiver.
- Connect the equipment into an outlet on a circuit different from that to which the receiver is connected.
- Consult the dealer or an experienced radio/TV technician for help.

CAUTION: Any changes or modifications made to this equipment may void the user's authority to operate this equipment.

© 2009 Seagate Technology LLC. All rights reserved. Seagate, Seagate Technology, the Wave logo, FreeAgent, and Theatre are trademarks or registered trademarks of Seagate Technology LLC or one of its affiliated companies in the United States and/or other countries. All other trademarks or registered trademarks are the property of their respective owners. When referring to hard drive capacity, one gigabyte, or GB, equals one billion bytes and one terabyte, or TB, equals one thousand billion bytes. Your computer's operating system may use a different standard of measurement and report a lower capacity. In addition, some of the listed capacity is used for formatting and other functions and will not be available for data storage. Seagate reserves the right to change, without notice, product offerings or specifications.

Seagate Technology LLC
920 Disc Drive
Scotts Valley
CA 95066 U.S.A.



100546536



6

Access the FreeAgent® | Theater™ Media Player User Guide on the Installation CD

Refer to the User Guide for information about the FreeAgent | Theater media player:

1. Insert the Installation CD for the FreeAgent | Theater media player in your computer.

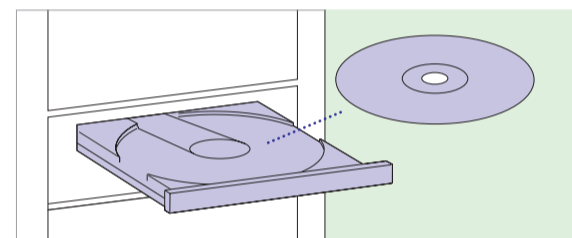

2. In the *Select Language* window, click the language in which you want to read the User Guide.



3. On the main menu, click *User Guides*. The User Guide for the FreeAgent | Theater media player opens.



7

Using the Remote Control

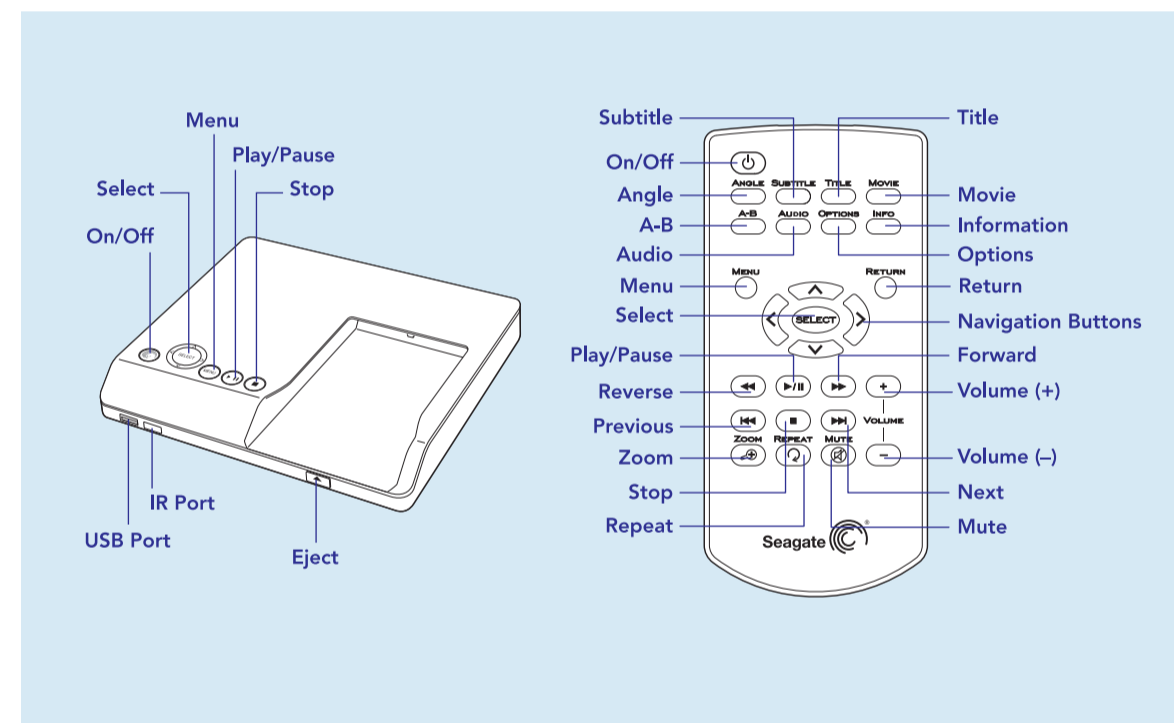

Remote Control

	On/Off
	ANGLE: Switch a movie angle.
	SUBTITLE: Activate available subtitle.
	TITLE: Open the movie title menu.
	MOVIE: Open the movie main menu.
	A-B: Select start (A) and end (B) point in a video and replay that portion.
	AUDIO: Select a language for an audio track in a file.
	OPTIONS: Movies: Search Title/Chapter/Time. Photos: Change from list to thumbnail view.
	INFORMATION: Display media information, such as file properties or elapsed time.
	MENU: Open the main menu.
	RETURN: Return to previous screen. Photos: Change from Thumbnails to list view.
	SELECT: Confirm menu selection.
	Navigation Buttons: Press the arrow buttons to navigate the menus.

	REVERSE/FORWARD: Press repeatedly to increase speeds.
	PLAY/PAUSE
	PREVIOUS/NEXT: Music or Photos: Go to previous or next file. Video: Go to previous or next chapter. File List: Page up or down.
	STOP
	VOLUME: Volume up or down.
	ZOOM: Zoom in or out when playing photos or movies.
	REPEAT: Repeat selection.
	MUTE: Mute audio.

Media Player

	On/Off
	Navigation Buttons: Press the arrow buttons to navigate the menus. SELECT: Confirm menu selection.
	MENU: Open the main menu.
	PLAY/PAUSE
	STOP
	EJECT

FreeAgent® | Theater™ Media Player Setup Guide

FreeAgent® | Theater Media Player Box Contents

1. FreeAgent | Theater Media Player
2. Remote Control
3. FreeAgent | Go Drive
4. PC Dock with USB Cable
5. Audio/Video Cable
6. Power Adapter
7. FreeAgent | Theater Media Player Installation CD with Application Software and User Guide

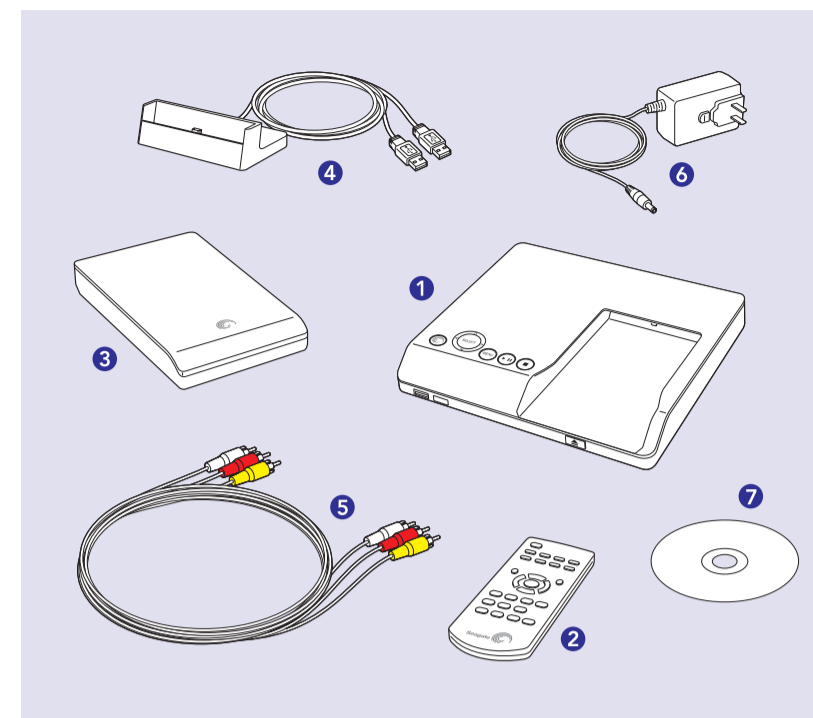

1

Set Up the FreeAgent® | Theater™ Media Player Components

Connect the FreeAgent | Theater media player to your TV:

Connect the yellow, red, and white audio/visual cables to the matching outlets on the back of your FreeAgent | Theater media player and your TV.

- For HD output, use the Component Video connections (cable not included).
- For digital audio, use the Coaxial connection (cable not included).

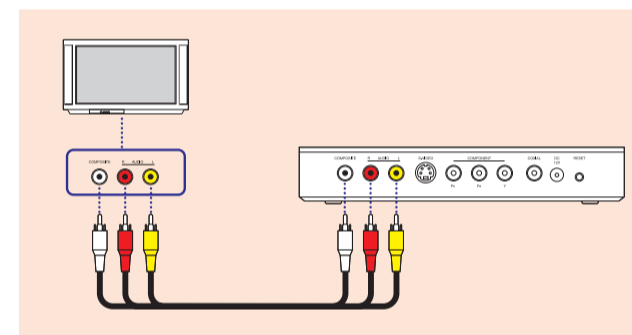

Plug in the media player. The power LED on the front of the unit flashes amber while the media player starts up.

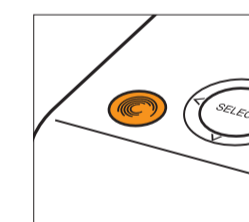

- Flashing amber light:** Starting Up
- Solid amber light:** Standby

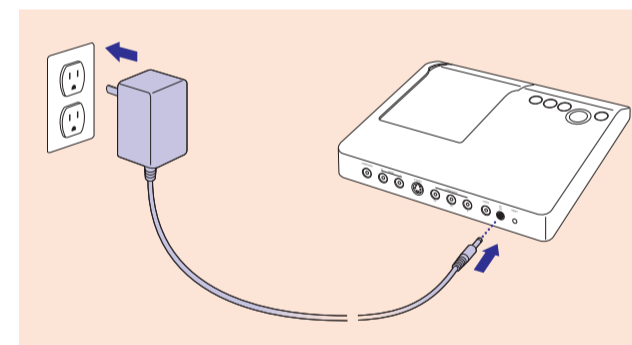

2

Connect the FreeAgent® PC Dock to Your PC

Connect both USB plugs on the PC dock cable to USB ports on your computer or hub.

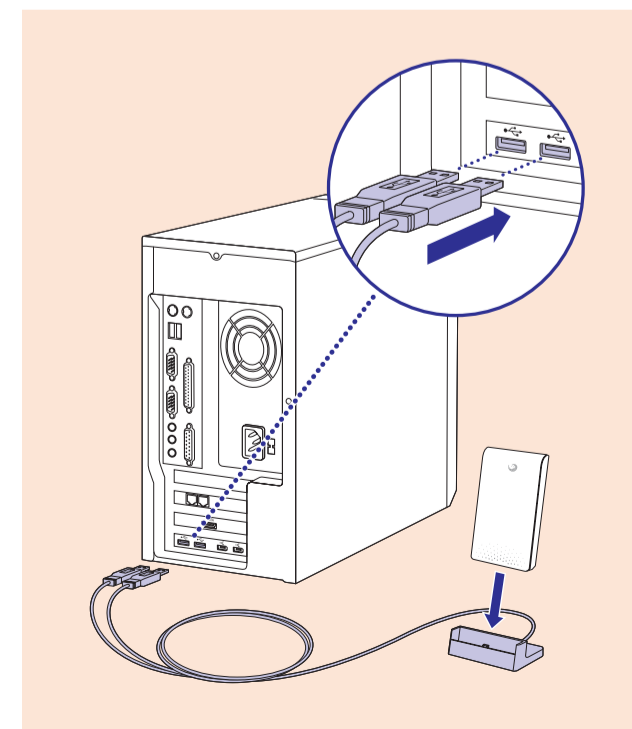

Insert the FreeAgent | Go drive in the PC dock to copy media files from your computer for play on your TV.

3

Install the FreeAgent® | Theater™ Media Player Software

1. Insert the Installation CD for the FreeAgent | Theater media player in your computer.

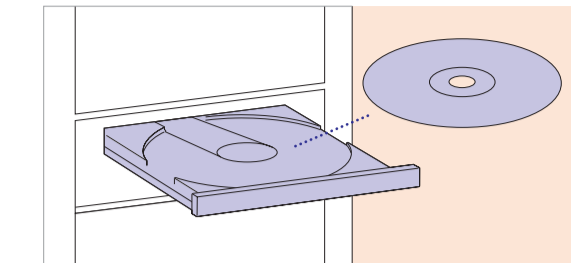

2. In the *Select Language* window, select your language.



3. Install the FreeAgent | Theater media player software. Set up and use the software to automatically synchronize media files to your FreeAgent | Go drive.



4

Transfer Files to the Drive and Connect the Drive to the Media Player

Use the Media Sync software to automatically place media files in the correct location on the drive so the media player can access them.

To place files on the drive manually, refer to the User Guide.

Be sure to use Safe Removal when disconnecting the drive from the PC. Click the Safely Remove Hardware icon in the Windows System Tray. A pop-up window will notify you when it is safe to remove the device.

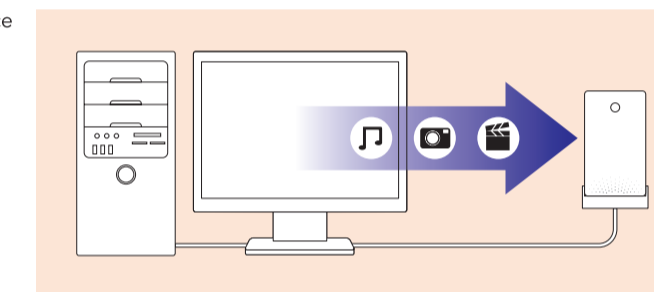

Insert the FreeAgent | Go drive in the media player to play media files on your TV.

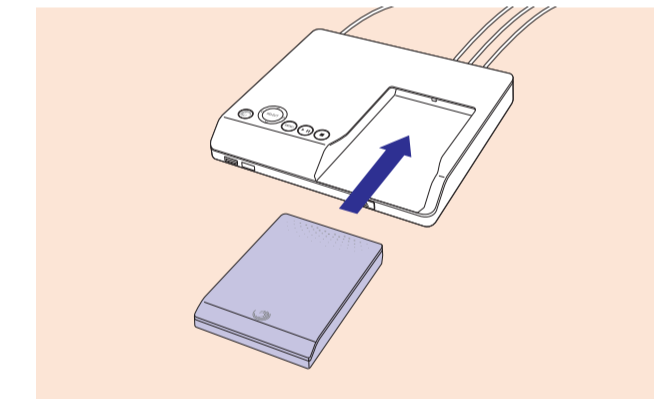

WWW.SEAGATE.COM

- Visit us at our Support pages for assistance with
- **Installation:** Additional instructions and troubleshooting assistance
 - **KnowledgeBase:** FAQ's, How to use this product
 - **Download Center:** Installation software, utilities, and diagnostics
 - **Warranty Information**
 - And all of your other storage needs

A soft copy of your comprehensive **User Guide** is included with your product. Click the **Help Icon** for assistance.

To contact Support, visit us at our **Contact Us** page.

Note: To protect your data, always follow the safe removal procedures for your operating system when disconnecting your product.

5

Remove the battery film from the remote.



Use the remote control or the power button to turn on the media player. Switch TV input to display the FreeAgent | Theater media player.

- Solid white light:** Media player ready

